



# Zeta 2.3" Linear

Architectural LED Luminaire



## Exquisite

### Clean lines. Sleek styling

This ZE 2.3" direct/Indirect solution does it all, in a system with a small scale 2.3" extruded profile that not only provides straight lines but also well-controlled ambient lighting with separate control of direct and indirect lighting. It's an excellent choice for commercial and retail ambient applications

- Available in suspended, recessed, surface and wall mount.
- Individual units, continuous runs or patterns with 90-degree or 120-degree joiners.
- Direct/Indirect light may be specified and controlled independently.
- Diffuser, louver, micro reflector and deep regressed lens options.
- Lumen output range:
  - Direct up to 1050 lumens per foot
  - Indirect up to 1150 lumens per foot



## Combining Architectural Aesthetics With Visual Comfort

Flexible and sophisticated, the linear lighting families featured in top finishes, with professional optics and unprecedented performance.

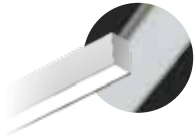

**Diffuser**  
It allows the light to custom the diffuser lengths, up to 42'.

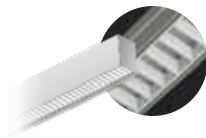

**Louver**  
Straight blade louver, allows the light to diffuse for a direct and indirect lighting combination.

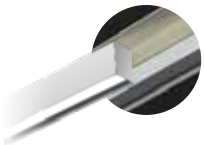

**Deep Regressed**  
A snap-in lens for easy custom colors and visual comfort.

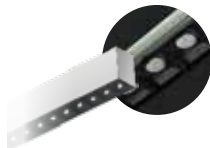

**Micro Reflector**  
Exclusive low glare modular optics, UGR<15.

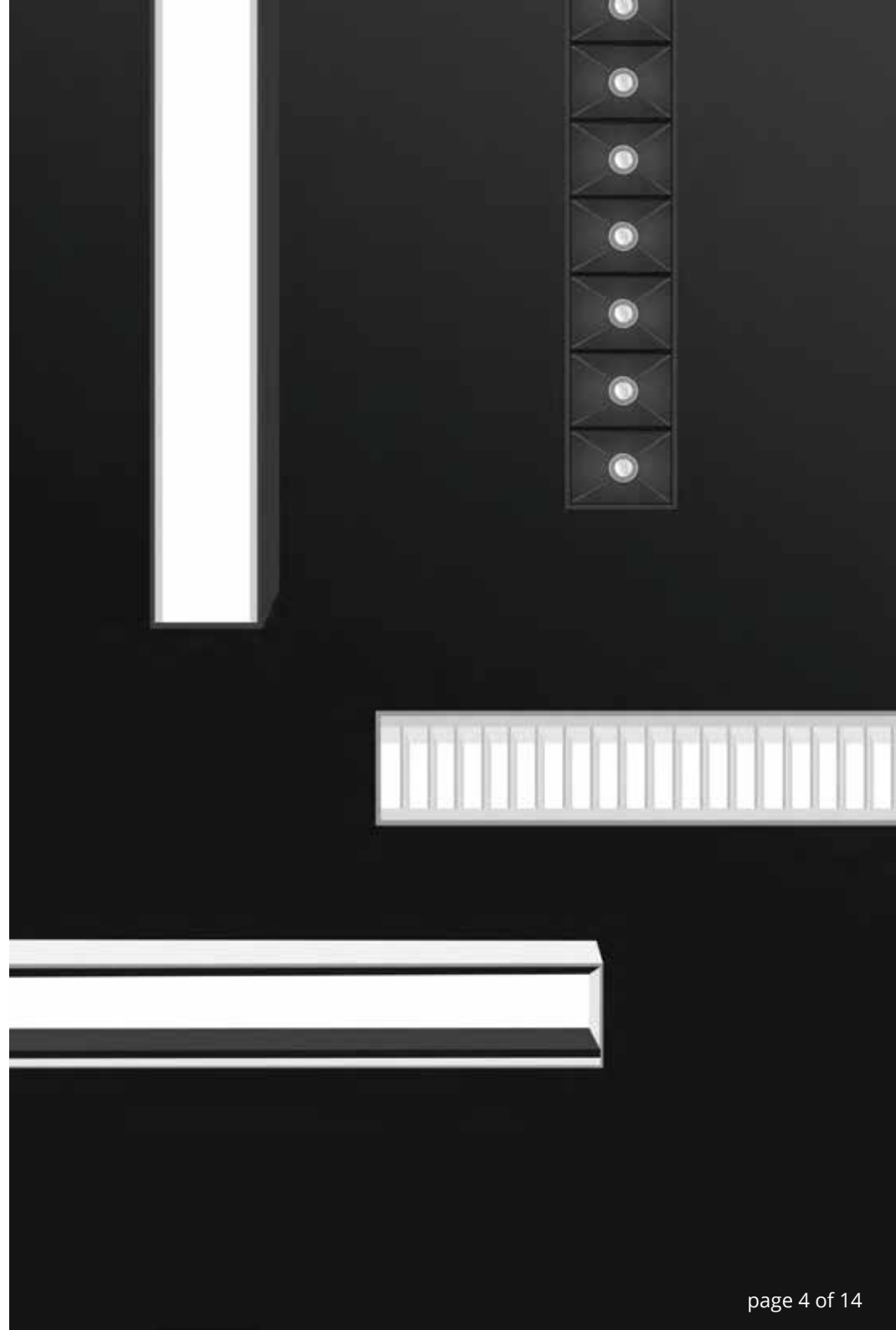

## Powerful "7 IN 1" 7 Lighting Distributions

The Zeta series can provide smooth direct or indirect lighting distribution.  
\* "7 in 1" 7 embedded lighting distributions adjusting by dip switch.

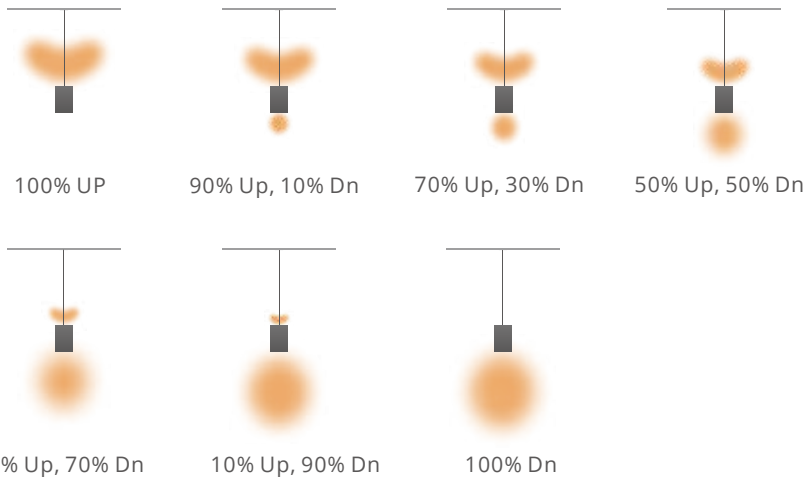

\* Smoothly control direct/indirect lighting distributions by a remote 0-10V dimmer.

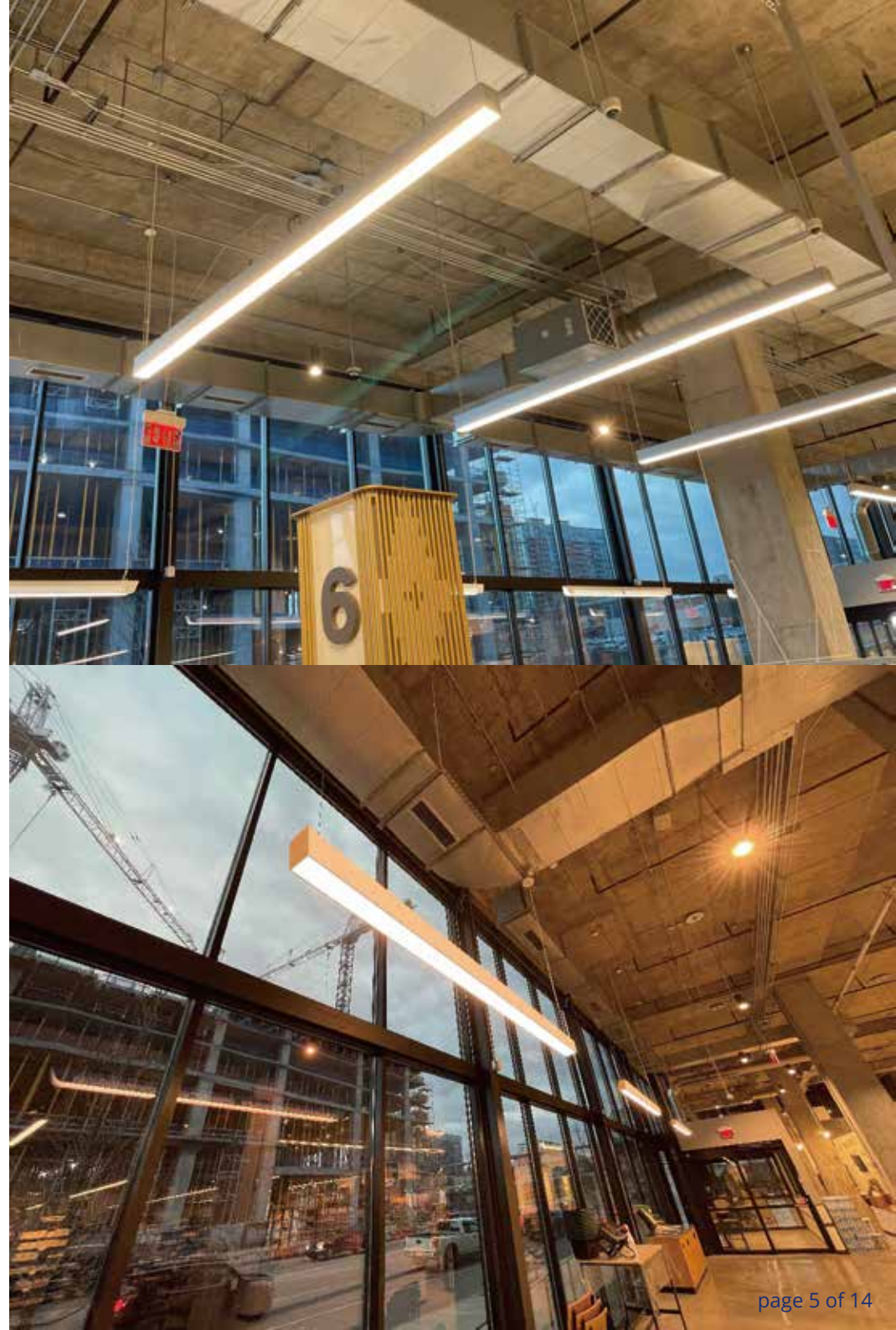





## The Art of Design Flexibility

All linear line products offer the freedom to create truly dynamic spaces. 5 joiners make it easy to create multiple fixture configurations for exceptional design flexibility. For additional design flexibility, individual or row-mounted options are available in a variety of run lengths and lamp configurations.

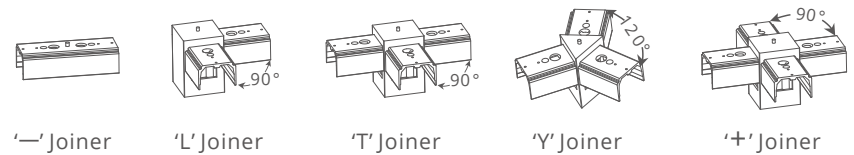

'I' Joiner

'L' Joiner

'T' Joiner

'Y' Joiner

'+' Joiner

## Open Ceiling Is The New Trend

### Product Performance

Shape: Y		Mounting: Suspended
Qty	Parts	
3	4' Linear Light (Direct / Indirect)	
1	Y Joiner	
3	End Cap	
4	Suspension Kit	
2	4" Power Feed Canopy	
2	2" Non-power Feed Canopy	
2	AC Cable	

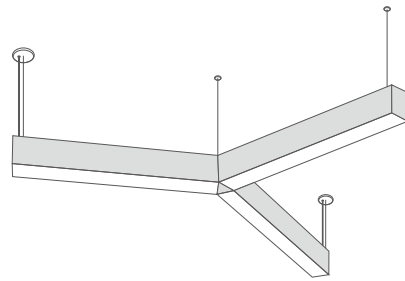



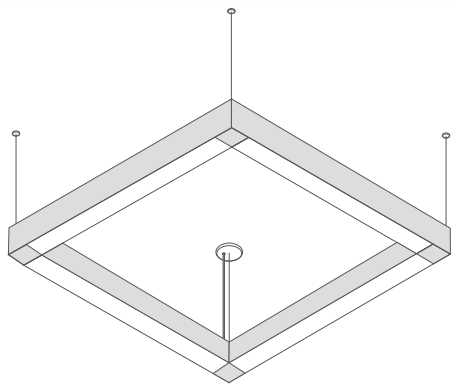

### Product Performance

Shape: □   Mounting: Suspended	
Qty	Parts
4	4' Linear Light (Direct / Indirect)
4	L Joiner
0	End Cap
4	Suspension Kit
1	4" Power Feed Canopy
3	2" Non-power Feed Canopy
1	AC Cable



## Product Performance

Shape: Line	Mounting: Suspended
Qty	Parts
4	4' Linear Light (Direct / Indirect)
4	— Joiner
2	End Cap
5	Suspension Kit
1	4" Power Feed Canopy
4	2" Non-power Feed Canopy
1	AC Cable
1	42' Continuous Roll-Out Lens

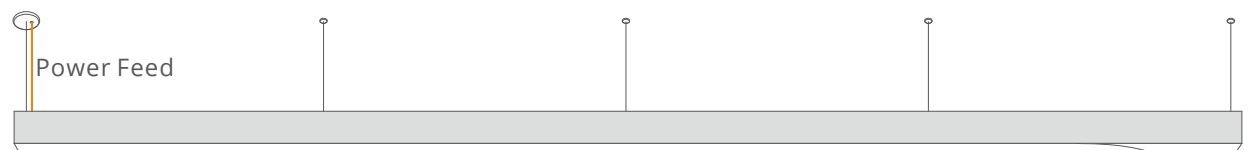

It is linear, available in runs of virtually any length.  
Each power feed works:

- Up to 40ft in 120V AC.
- Up to 100ft in 277V AC.

  
42' Continuous Roll

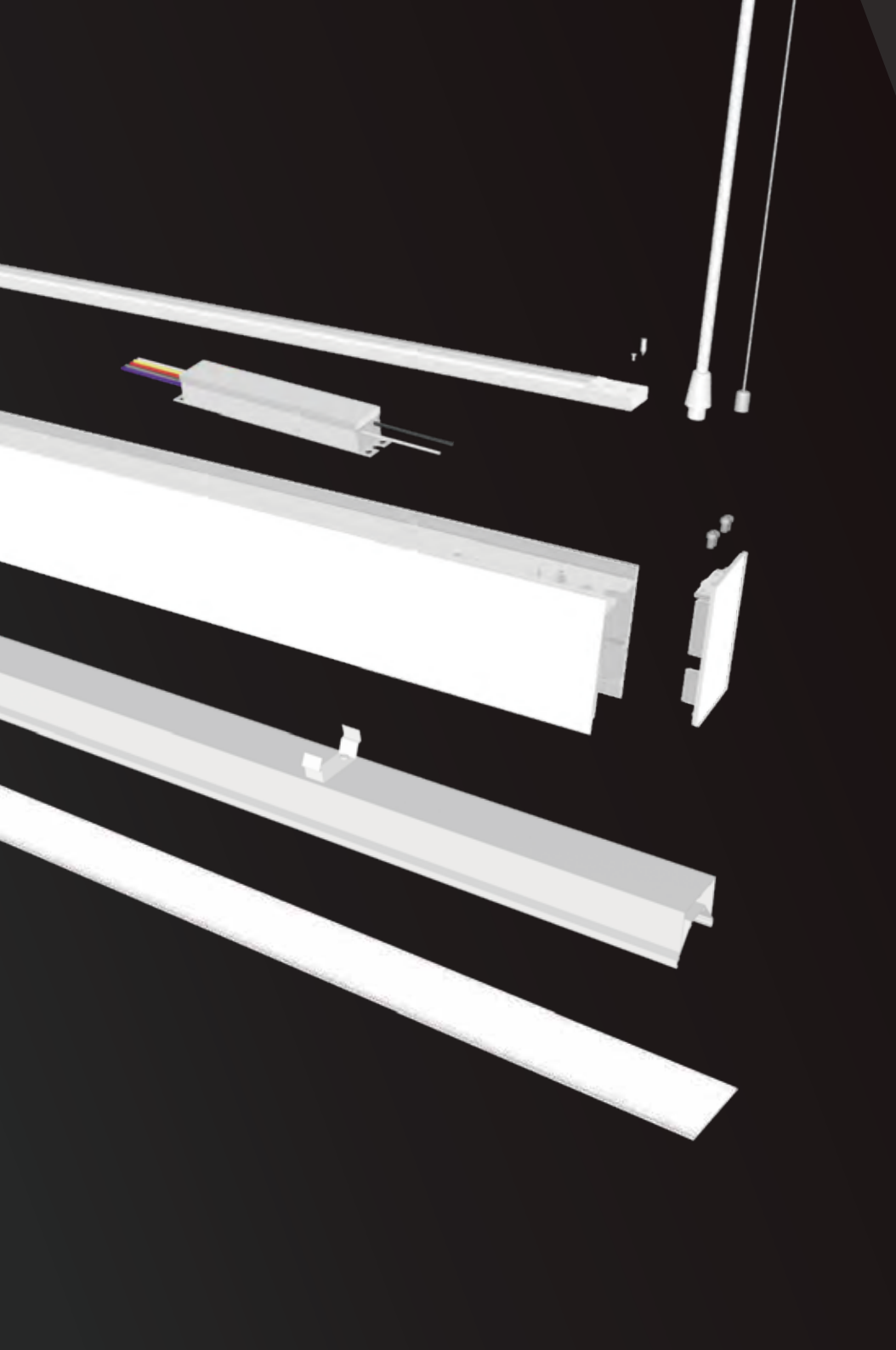

Zeta 2.3" Series

Architectural Linear



## Elegant Design Blending Precise Performance

### **Functional Style**

Built on the core of its modern, the Zeta series allow easy access to critical components to simplify installation or in the event that repair or replacement of different CCT becomes necessary.

### **Ease Of Installation**

Engineered to help reduce installation costs, with a simple joining and alignment mechanism that optimizes the stability and straightness of patterns and continuous runs

## Application Flexibility

### Four Mounting Options



#### Suspended

Best suited to spaces with generous ceiling heights. Light up the space to improve comfort with the indirect lighting option and various canopies.



#### Surface

It is the ideal choice for low ceilings and minimal ceiling spaces. Surface mounted luminaires can be used effectively to enhance architectural features.

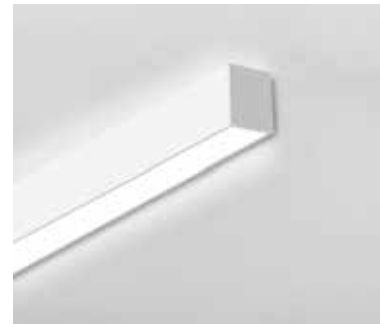

#### Wall Mount

Delivers visually appealing ambient lighting and enhanced design and application flexibility.

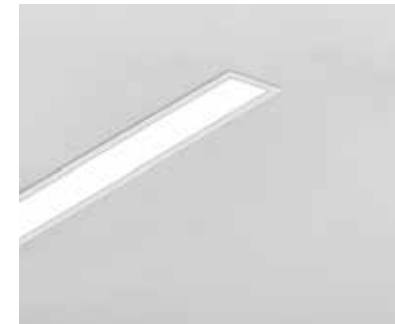

#### Recessed

Clean, uninterrupted lines maximize the space within a room. It offers a nominal 2.3" aperture for a sleek, minimalist slot look.



1.6 in. round 4.5 in. round 1.6 in. square 4.5 in. square



**Diffuser**

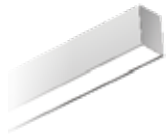

**Length & Wattage**

2' 20W  
4' 40W  
8' 80W

**Efficacy\***

1050lm/ft

**Beam Angle**

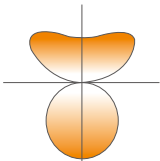

Up 150°, Down 110°

**Louver**



**Length & Wattage**

2' 20W  
4' 40W  
8' 80W

**Efficacy\***

900lm/ft

**Beam Angle**

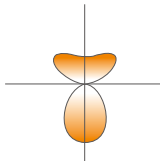

Up 150°, Down 80°

**Micro Reflector**

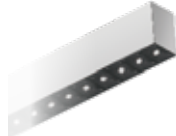

**Length & Wattage**

2' 20W  
4' 40W  
8' 80W

**Efficacy\***

950lm/ft

**Beam Angle**

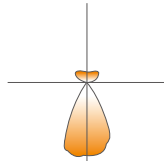

Up 150°, Down 60°

**Deep Regressed**



**Length & Wattage**

2' 20W  
4' 40W  
8' 80W

**Efficacy\***

950lm/ft

**Beam Angle**

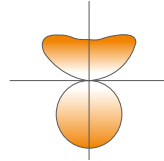

Up 150°, Down 75°

\*Base on 50% up & 50% down light distribution with 3500K.

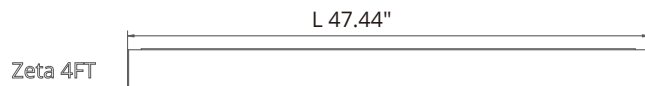
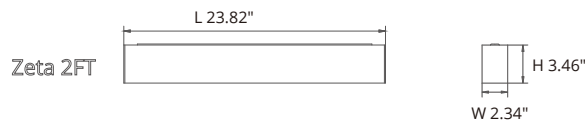

Color Temp: 3000K,3500K,4000K

**LED**

Color Temp: 3000K,3500K,4000K

CRI: 80+ or 90+ Optional

Lifetime: >50,000H L70 minimum

**Driver**

Internal Driver: 100-277V AC or 110-347V AC

Direct And Indirect Lighting Distribution Adjustable

Wattage Adjustable (100%,75%,50%)

Dimming: 1-10V

Tested Dimmers: Lutron® Diva-Dvtv, Leviton® IP-710-DL

**General**

Finish: White or Custom

Materials: Anodised Aluminium

Listings: UL, Damp Rated

Warranty: 5 Years Limited

**Mounting**

Custom Pattern

Pendant, Surface, Wall Mount And Recessed Available

**Function Options**

Emergency Option

Sensor Option

